

BOSS

SP-1

Spectrum

INSTRUCTIONS



• Please read these instructions carefully for proper operating procedures for the BOSS SP-1.

BEFORE USING SP-1

- When operating SP-1 from AC line, use BOSS AC Adaptor for SP-1.
- Avoid using SP-1 in very dusty location or under high temperature or humidity conditions.

CONNECTING SP-1

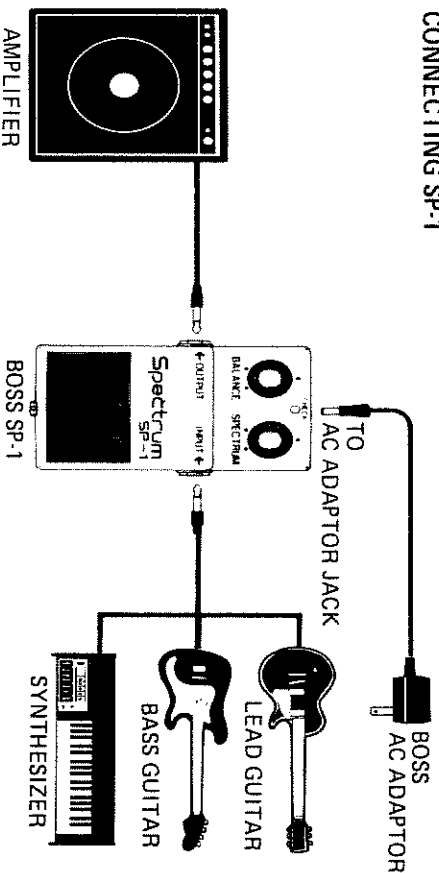

CAUTION: The output sound may be distorted at a limited frequency range which is determined by Spectrum control to create a peak. Set level controls of instrument and amplifier to proper position to avoid such trouble.

OPERATING SP-1

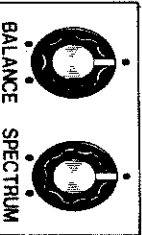
- 

After connecting all cords required, set all knobs on the panel as illustrated.
- Tread the pedal to check battery. If check lamp lights, battery is live.
* If lamp does not light, which means dead battery, replace with a new battery.
- Tread pedal to set the unit in the state that sound is effected.
- 

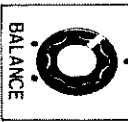
Turn Spectrum knob to proper position.
- 

Turn Balance knob to proper position to obtain well-balanced volumes of Normal and Effect modes.

NAME AND FUNCTIONS

BOSS Spectrum SP-1 is a perfectly new effect unit; it adds variety to the original sound by emphasizing a limited frequency range of the sound spectrum. The emphasis frequency can be continuously variable between 500Hz and 5KHz. It is especially efficient when used at high frequencies. Also it will give you a unique tone, used with a bass guitar.

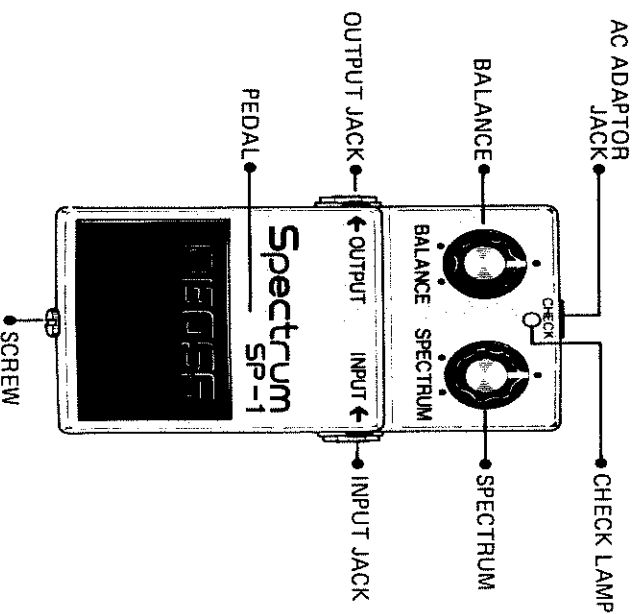

SPECTRUM

The frequency to be emphasized can be continuously changed from 500Hz to 5KHz by this knob. The frequency becomes higher when turned clockwise (↻), and lower when turned counterclockwise (↺).

BALANCE

This knob controls volume balance of Normal and Effect modes. Turn clockwise to boost Effect volume and counterclockwise to boost Normal volume.

* The total volume is constant without regard to Balance control setting position.

INPUT JACK

This input jack receives output from electric guitar and other electronic instruments.

OUTPUT JACK

This jack feeds signal to amplifier.

AC ADAPTOR JACK

SP-1 operates both from self-contained battery (9V) and from AC line. Connect a BOSS AC Adaptor (DC9V) to this jack,

and the battery is disconnected from the circuit, guaranteeing stable long-time performance.

PEDAL SWITCH

This is a changeover switch for Normal or Effect. By use of **FET ELECTRONIC SWITCH**, first in these kinds of small size effect units, pop noise is perfectly eliminated and OD-1 can be satisfactorily employed even in studio recording.

CHECK LAMP

While pedal is trod down, this lamp lights if battery is normal. Thus this lamp lets you confirm the changeover between Effect and Normal modes, and also battery state.

If the indicator fails to light, replace the battery with a new one.

SCREW

When replacing battery, loosen this screw to open the casing. Do not remove of the screw from the pedal. If you do, be careful not to lose it.

CAUTIONS FOR REPLACING AND HANDLING BATTERY

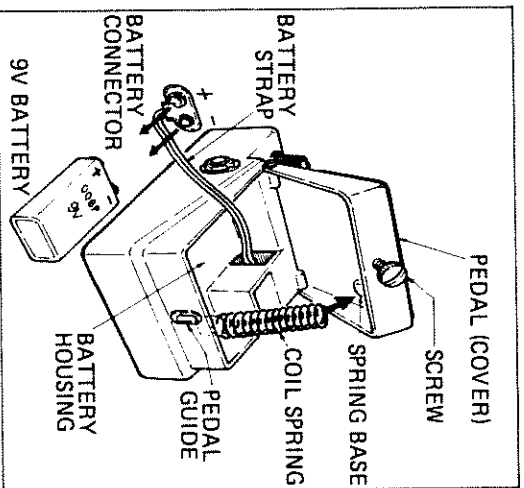

REPLACING BATTERY USE ONE 9-VOLT BATTERY.

- ❶ Loosen the screw of pedal to open it and take out battery from its housing.
- ❷ Replace the battery by a fresh one and put it into position.
- ❸ Set coil spring onto the projection on the rear of the pedal and shut the cover (pedal). Finally, insert the screw into the pedal guide and tighten it.
At this time, be careful not to catch the battery strap in the cover or coil spring.

CAUTIONS

- When you don't use for a long period, remove the battery to prevent current leakage and leaking out of sticky substance.
- If battery voltage drops, effect becomes inferior or no sound is produced. To prevent that, replace the battery a little earlier.
- Be sure to keep the battery snapped by connector into the housing, when using AC adaptor, too.
- Even if AC Adaptor cord comes out during performance, operations immediately changes to battery, causing no trouble in continued performance.
- Power is switched on while a plug is put into input jack. When you do not use, keep the plug off the jack.

AC ADAPTOR (OPTION)

When you operate SP-1 from AC line, use AC Adaptor for SP-1.

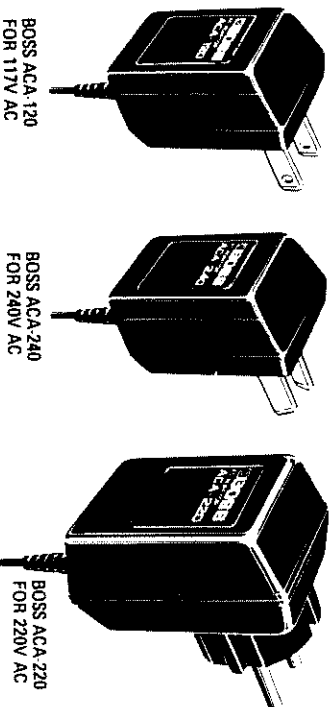

SPECIFICATIONS

Power	Battery 9V (1) AC Adaptor
Current draw	DC9V, 3.5mA
Control	Spectrum (500Hz – 5KHz continuous), Balance Normal/Effect Changeover Switch, Battery Check Lamp (also for confirmation of Normal/Effect changeover)
Jack	Input, Output, AC Adaptor
S/N ratio	Over 80dB
Input impedance	220K Ω
Output load impedance	Over 600 Ω
Dimensions	70(W) x 55(H) x 125(D)mm
Weight	400g

* Specifications are subject to change without notice.

コンパクトシリーズのインジケーターがかわりました。

NOTICE:

There has been a change in the LED indicators of the Boss compact series pedals.

Instead of being merely a battery checker which lights only when the pedal is depressed, the LED now goes on whenever the effect is on; therefore, the ON/OFF status of the effect can be seen at a glance.

If the LED is dim when the effect is on, or does not light at all, this is an indication that the battery needs replacing.

コンパクトインジケーターは、バッテリーチェッカーだけでなく、エフェクトインジケータとしても動作します。エフェクト時にはインジケーターが点灯したままになり、ノーマル時にはインジケーターが消えます。使用中インジケーターが、暗くなったり点灯しなくなった場合は、電池が消耗していますので早めに新しい電池と交換して下さい。

 **BOSS**

Products of Roland

Printed in Japan '78 Dec. B-3

 Roland®

10423

UPC 10423



1991

 **BOSS**